



***Columns - Cornices - Porticos***

# Columns



For over thirty years Mexboro Concrete has been at the forefront of manufacturing high quality architectural cast stone. The company is now able to offer a wide range of classical components incorporating the basic elements of Greek and Roman architecture which will enliven building facades and landscapes. These classical designs have been faithfully reproduced by skilled craftsmen and then hand finished to produce a product virtually identical to quarried stone in appearance and texture, but at a fraction of the cost.

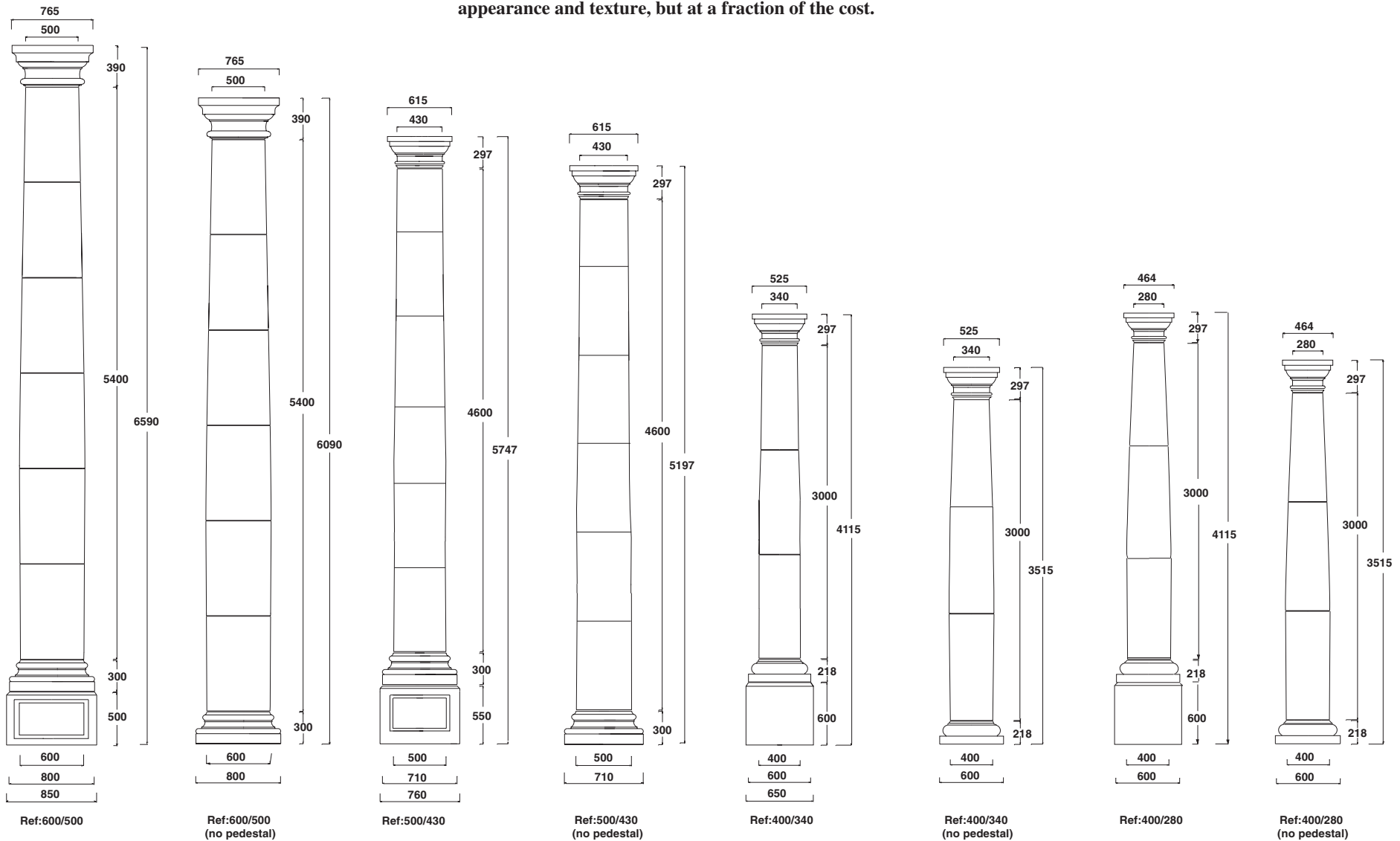

# Columns

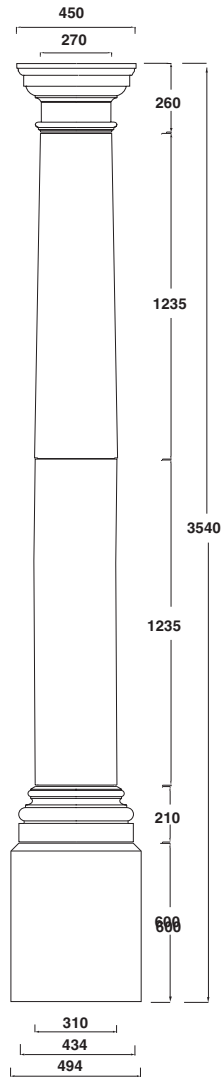

Ref:310/270

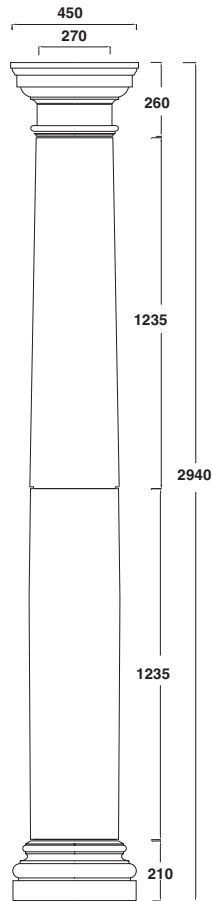

Ref:310/270  
(no pedestal)

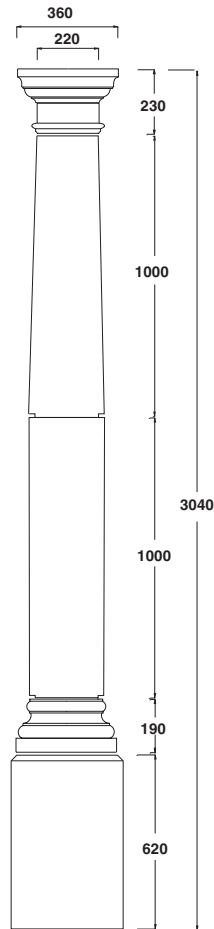

Ref:260/220

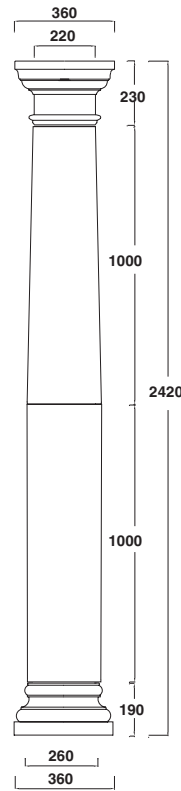

Ref:260/220  
(no pedestal)

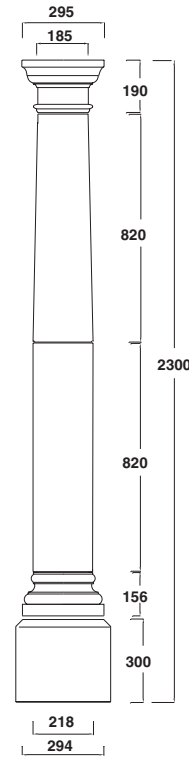

Ref:218/185

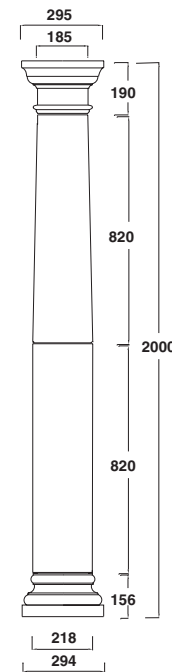

Ref:218/185  
(no pedestal)

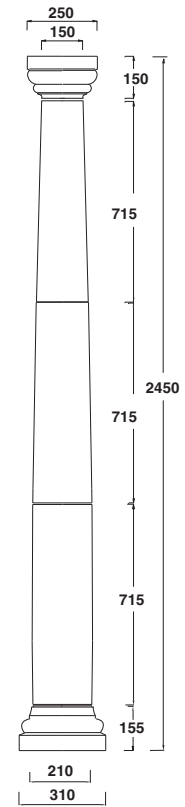

Ref:210/150

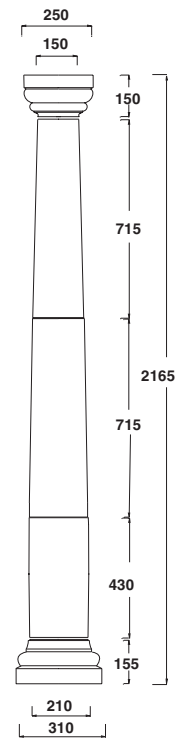

Ref:210/150  
(1860 shaft)

# Cornice

These standard units allow great design flexibility. They can be 'mixed and matched' to provide a remarkably flexible and extensive range of Architrave / Cornice design combinations.



## ARCHITRAVE (Components)

Ref: ARCH/PLAIN  
(Plain)

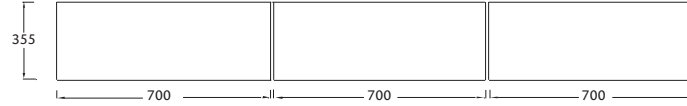
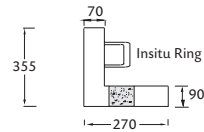

Ref: ARCH/NIB  
(With nib)

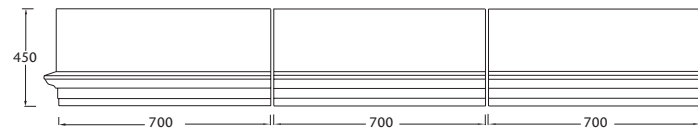
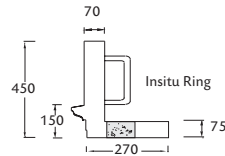

## UPPER CORNICE (Components)

Ref: U.CORN/75

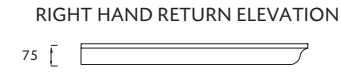
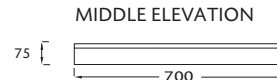
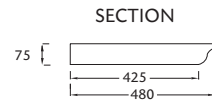

## CORNICE (Components)

Ref: U.CORN/75

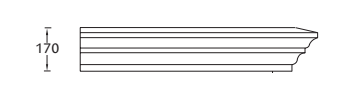
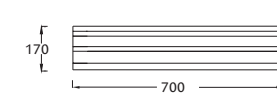
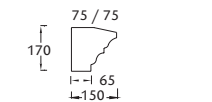

Ref: CORN/250

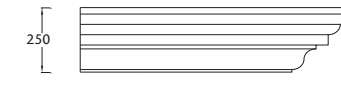
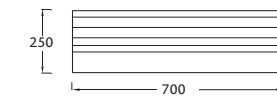
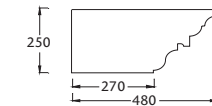

Ref: CORN/220

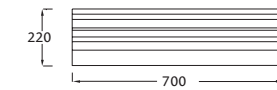
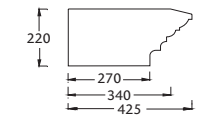

Ref: CORN/DW/150

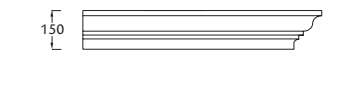
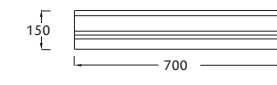
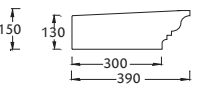

Ref: CORN/150

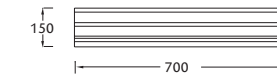
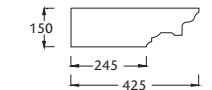

## DENTIL COURSE (Components)

Ref: DEN/90

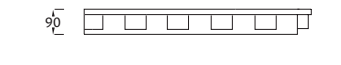
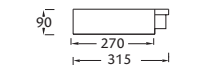

# Porticos

Typical portico elevations built using standard Architrave, Cornice and Dentil components. Mexboro porticos will enhance any entrance and transform the appearance of a modern or traditional building. In addition to the extensive range of standard products, Mexboro specialises in restoration work and in the manufacture of custom-made porticos and columns to individual designs. Please speak to our design team about your requirements.

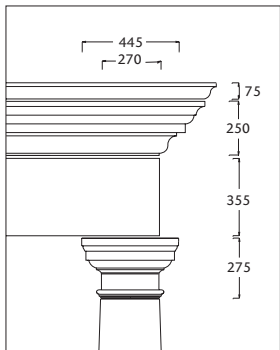
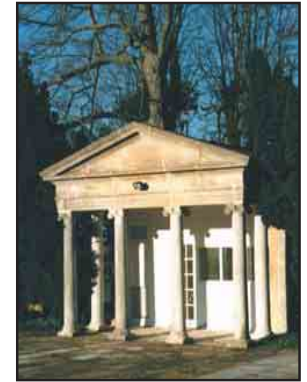

Plain architrave with 250 cornice and upper cornice.  
 Ref: ARCH/PLAIN, CORN/250, U.CORN/75.

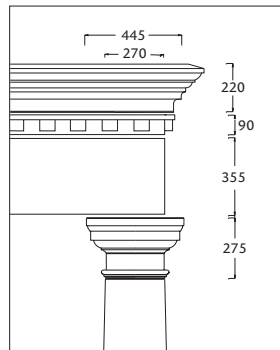

Plain architrave with dentil course and 220 cornice.  
 Ref: ARCH/PLAIN, DEN/90, CORN/220.

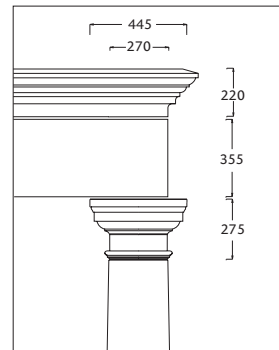

Plain architrave with 220 cornice.  
 Ref: ARCH/PLAIN, CORN/250.

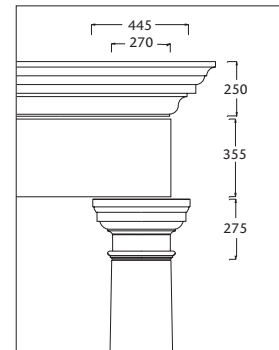

Plain architrave with 250 cornice.  
 Ref: ARCH/PLAIN, CORN/250.

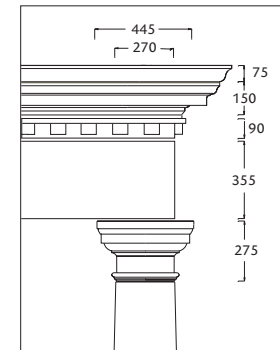

Plain architrave with dentil course and upper and lower cornice.  
 Ref: ARCH/PLAIN, DEN/90, CORN/150 U.CORN/75.

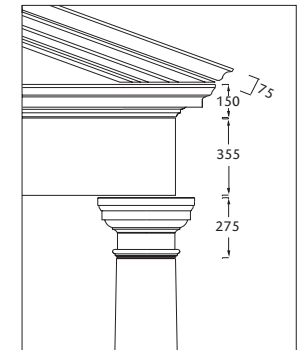

Plain architrave with triangular portico on 310/270 column.  
 Ref: ARCH/PLAIN, U.CORN/75, CORN/150, CORN/150.

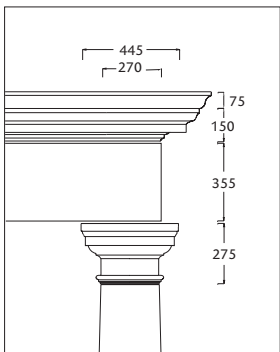

Plain architrave with upper and lower cornice.  
 Ref: ARCH/PLAIN, U.CORN/75, CORN/150.

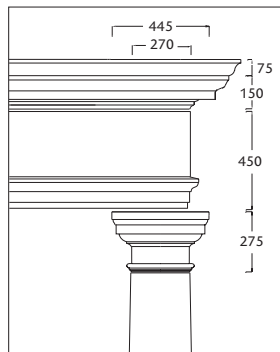

Architrave with nib and upper and lower cornice.  
 Ref: ARCH/NIB, U.CORN/75, CORN/150.

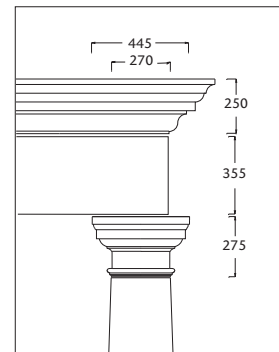

Plain architrave with 250 cornice.  
 Ref: ARCH/PLAIN, CORN/250.

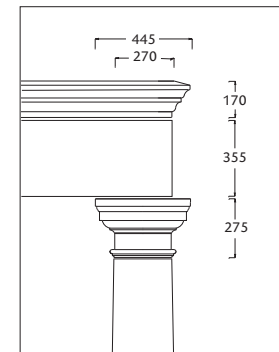

Plain architrave with 170 cornice.  
 Ref: ARCH/PLAIN, CORN/170.

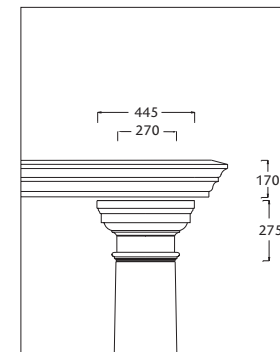

170 cornice.  
 Ref: CORN/170.

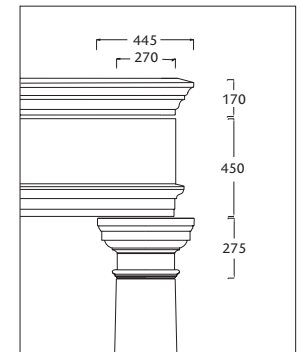

Architrave with nib and 170 cornice.  
 Ref: ARCH/NIB, CORN/170.

# Porticos

Units are decorative, manufactured with a central core to enable structural use. We recommend professional advice be sought in detailing of insitu concrete and reinforcement. An isolating medium should be used to accomodate differential thermal expansion between insitu core and decorative surrounds.

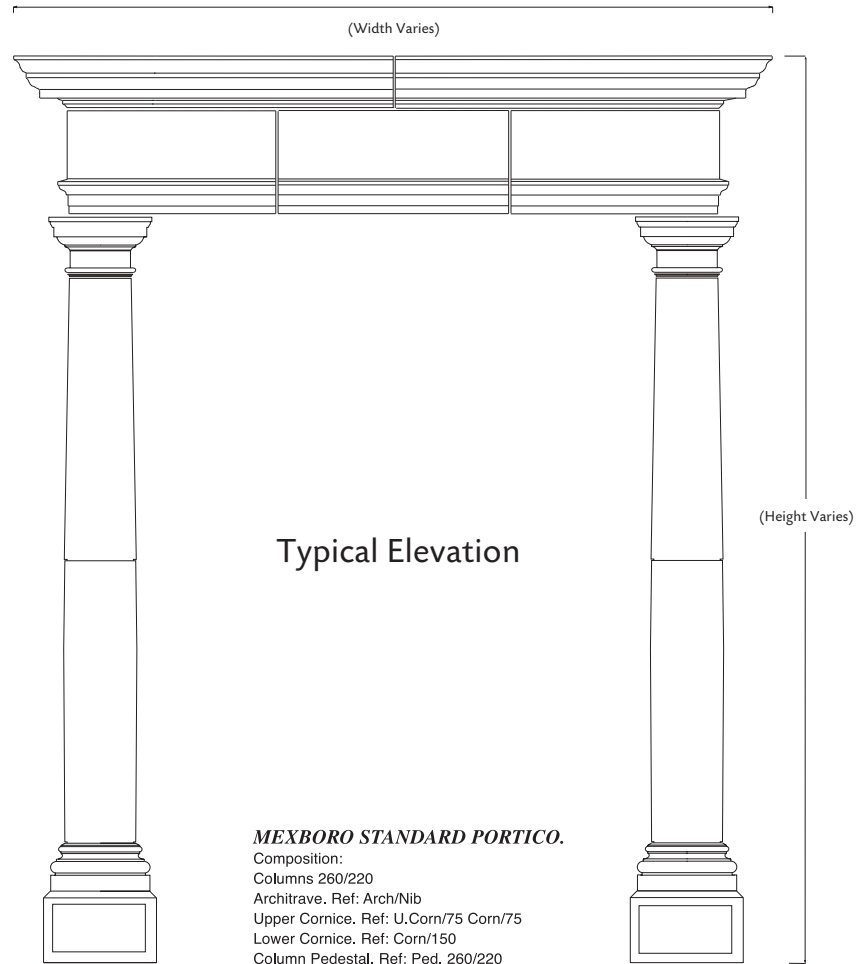
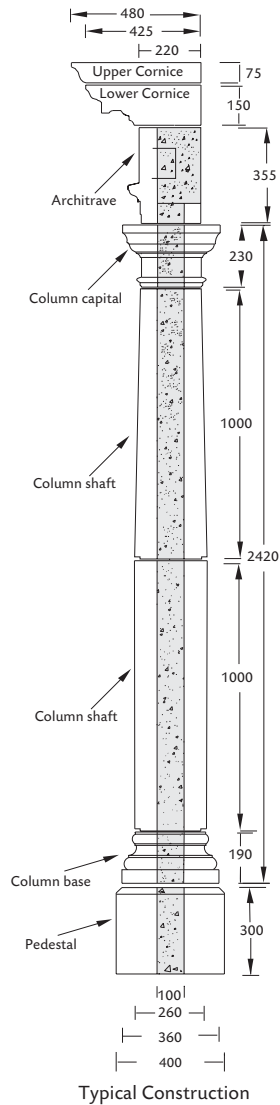



# Projects

## Recent MEXBORO Projects

Pictures show cast concrete products.

No: 1 Portico components, Guernsey property.

No: 2 Private residential, Lindridge Estate.

Portico with Wrought-Iron Balcony.

No: 3 Residential development, Plymouth.

No: 4 Private residential, Totnes.

No: 5 Harrods Village, Barnes, standard columns with

radius Architrave and Cornice to form Temple.

No: 6 Detail of half Columns used as Pilasters under

standard Architrave and Cornice units.

No: 7 Refurbishment of Pavillion.

No: 8 Private residential, Bristol, showing standard Portico

components, Window Surrounds, Quoin Stones,

Lintels, String course and Plinths.



1



2



3



4

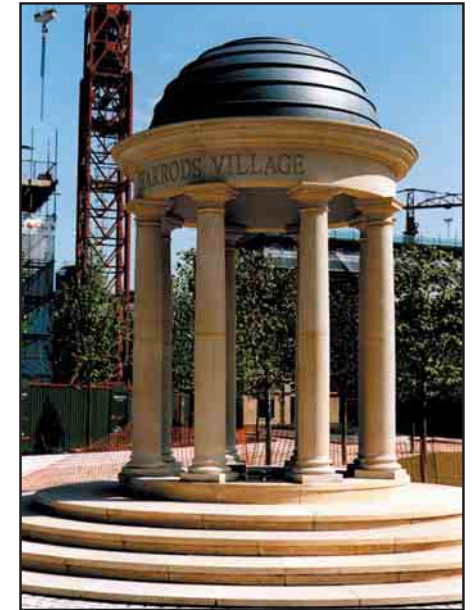

5



6



7



8

# Projects



9



10

### **Recent Mexboro Projects.**

Pictures show cast concrete products.

No: 9 Private residential, Totnes, Portico components.

No:10 Lindridge Estate, Gatehouse Balcony.

No:11 English Heritage, Refurbishment at Digby.

No:12 Private residential, Chudleigh, utilising standard Portico components.

No:13 Private Residential, Somerset, utilising both Standard and Special Cornice, Window Surrounds, Quoins, Dentil Course and Plinth Blocks.

No:14 Ugbrooke House, Chudleigh utilising standard Columns, Architrave and Cornice components to form a Covered Pergola.

No: 15 Private Residential, Bristol, entrance Portico.



11



12



13



14



15



**P**roduced in a range of mellow standard colours using a variety of natural crushed aggregates, the subtle shades and aesthetic beauty of cast stone allow it to harmonise well with most building fabrics whether traditional or new build. The Mexboro standard colours include Portland, Bathstone, Hamstone, Red sandstone, Yorkstone and Cotswold stone, although with precise pigment control virtually any colour, shade or hue can be achieved. The potential for the material is almost limitless due to the ease in which it can be moulded into intricate shapes and designs by the Mexboro mould makers and craftsmen. This enables Mexboro to undertake specialist ‘one-off’ projects to client’s individual requirements which are often prohibitively expensive to achieve in natural stone.

The versatility, appearance and performance of cast stone has led to a huge increase in its popularity. Whether it is used for the restoration and refurbishment of historic buildings and churches or on the other hand enhancing the aesthetic appeal of modern new build housing, institutional, commercial and public sector developments. The Company is proud to have been associated with the supply of cast stone to numerous prestigious developments throughout the country and abroad, including those under the direction of English Heritage, the National Trust, P.S.A and the Ministry of Defence. We welcome your enquiry about these or any other products within our standard range along with any special ‘bespoke’ designs envisaged. Contact our technical and sales team and give us the opportunity of working with you and together building on our nation’s architectural heritage.



**MEXBORO**



*The Cast Masters*

**MEXBORO CONCRETE LIMITED**

*Manufacturers of Architectural & Structural Concrete*

*Yalberton Industrial Estate, Alders Way, Paignton, Devon. TQ4 7QQ*

*Telephone: 01803 558025 Facsimile: 01803 524717*